

The APT (Adaptable Progression Tune) system allows the rider to adjust the progression of the air spring curve by adding or removing volume spacers in the fork's air chamber.

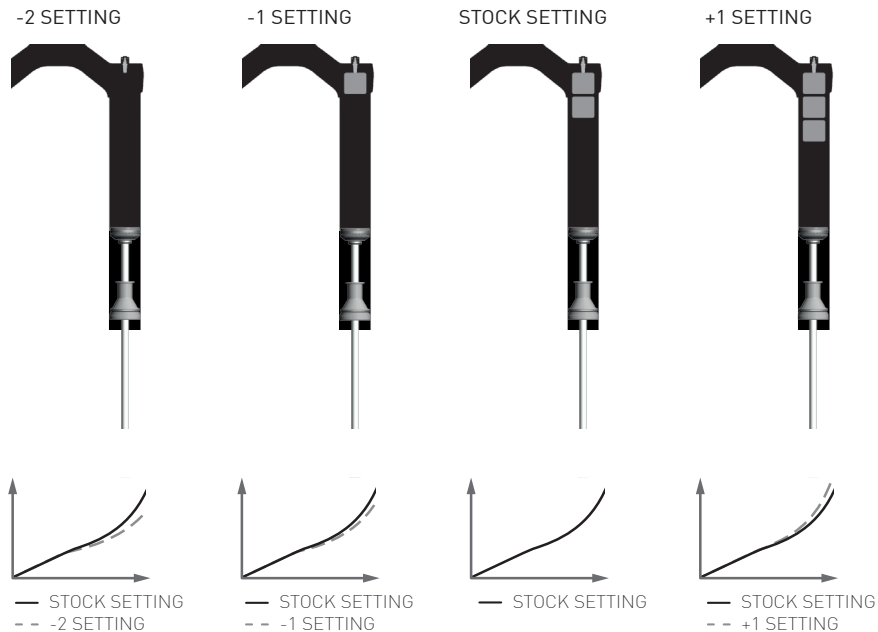

-2 SETTING: COMFORTABLE LINEAR: In this setting, without spacers, the suspension fork has a linear spring curve across the entire stroke and is barely progressive at the end of the travel. It is suitable for moderate off-road use by comfort-oriented riders.

-1 SETTING: RATHER COMFORTABLE, RATHER LINEAR: More ambitious riders looking for a rather comfortable setting use the setting with a single APT spacer. This offers a spring curve with a low progression for a smooth ride feel.

STOCK-SETTING: RATHER PROGRESSIVE: The stock setting of the forks has two APT spacers. This setting results in a rather progressive spring curve that gives more experienced riders the support they are looking for with their active riding style.

+ 1 SETTING: VERY PROGRESSIVE: When three APT spacers are used, the fork gets progressive and offers a direct ride feel. That makes this setting suitable for strong riders with an aggressive riding style.

NOTICE

The APT system only fits with forks with a hexagonal air chamber cap!

non hexagonal air chamber cap

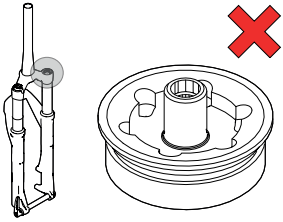

hexagonal air chamber cap

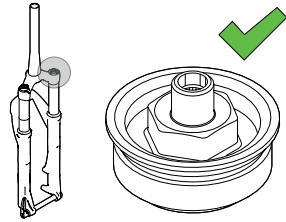

1. DEFLATING THE FORK

- Preparatory Steps:**
1. Clean the area of the air chamber cap.
 2. Remove the cover on the air spring side (only F 535 ONE).

1. Unscrew the valve cap.

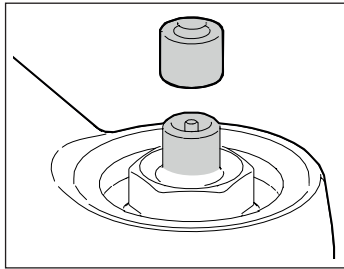

DANGER

Risk of injury due to high air pressure!

The valve must face away from your face while releasing the air!

2. Carefully press the back of the valve cap onto the valve insert and slowly release the air.
3. Slowly compress the fork two times about 10 mm with the valve insert pressed and pull it apart again.
→ This balances the positive and negative air chamber.

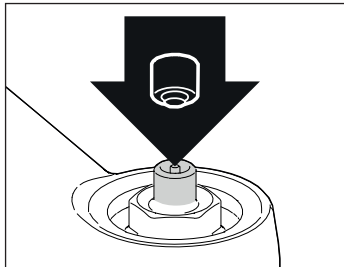

2. OPENING THE AIR CHAMBER

Required Material: 15 mm socket wrench

1. Make sure the valve cap is removed and the air is completely released.
2. Make sure that the area around the air chamber cap is clean to prevent dirt from entering the air chamber.
3. Unscrew the air chamber cap using a 15 mm socket wrench.
4. Pull the air chamber cap out of the air chamber.

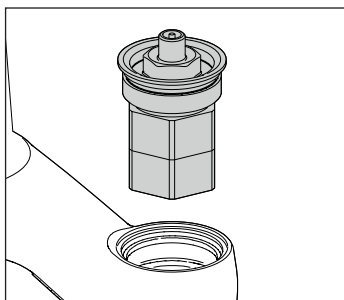
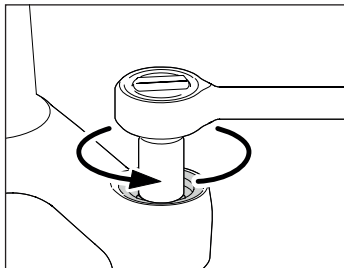

3. ADDING / REMOVING VOLUME SPACER(S)

NOTICE

Risk of damage through the installation of more than three volume spacers!

If more than three volume spacers are installed, the fork cannot compress completely.

- Never mount more than three volume spacers!

Required Material: 25 mm wrench (32 mm stanchions)
28 mm wrench (35 mm stanchions)

1. Add or remove volume spacer(s).
The maximum number of three volume spacers must not be exceeded!
2. Tighten the volume spacer(s) with a torque of 2 Nm.

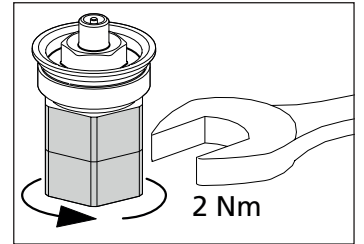

4. CLOSING THE AIR CHAMBER

Required Material: torque wrench with 15 mm socket

1. Remove the O-ring from the air chamber cap.
2. Clean the seat of the O-ring and the thread of the air chamber cap and grease it slightly.
3. Slightly grease the O-ring and put it back onto the air chamber cap.
4. Screw the air chamber cap onto the air chamber by hand.
5. Tighten the air chamber cap using a torque wrench with a 15 mm socket.

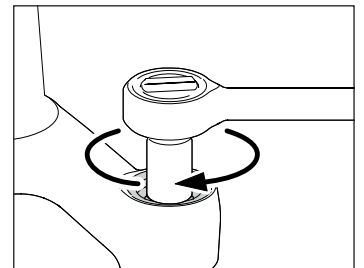
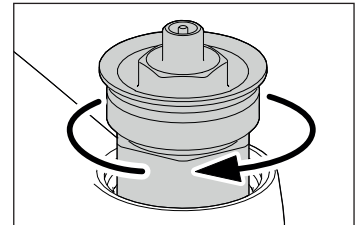
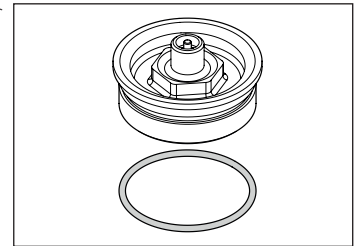

Torque:

- OPM & OPM Race: 10 Nm
- F 535 ONE: 25 Nm
- F 232 ONE: 15 Nm

5. INFLATING THE FORK

Required Material: DT Swiss shock pump

1. Inflate the fork. The air pressure should be set to your personal preferences and to the correct SAG (see manuals and how to videos on www.dtswiss.com).
2. Screw on the air chamber cap.

